

Traveling Salesman

Given a set of cities $(\{1, \dots, n\})$ and a symmetric matrix $C = (c_{ij})$, $c_{ij} \geq 0$ that specifies for every pair $(i, j) \in [n] \times [n]$ the cost for travelling from city i to city j . Find a permutation π of the cities such that the round-trip cost

$$c_{\pi(1)\pi(n)} + \sum_{i=1}^{n-1} c_{\pi(i)\pi(i+1)}$$

is minimized.

Traveling Salesman

Theorem 96

There does not exist an $O(2^n)$ -approximation algorithm for TSP.

Hamiltonian Cycle:

For a given undirected graph $G = (V, E)$ decide whether there exists a simple cycle that contains all nodes in G .

- ▶ Given an instance to HAMPATH we create an instance for TSP.
- ▶ If $(i, j) \notin E$ then set c_{ij} to $n2^n$ otw. set c_{ij} to 1. This instance has polynomial size.
- ▶ There exists a Hamiltonian Path iff there exists a tour with cost n . Otw. any tour has cost strictly larger than $n2^n$.
- ▶ An $O(2^n)$ -approximation algorithm could decide btw. these cases. Hence, cannot exist unless $P = NP$.

Gap Introducing Reduction

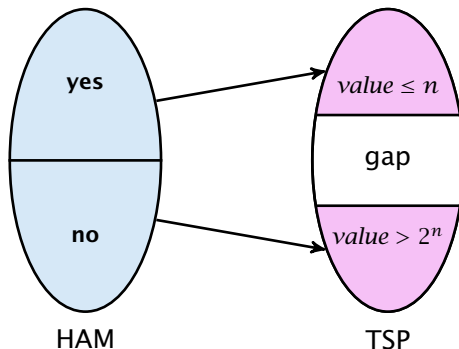

Reduction from Hamiltonian cycle to TSP

- ▶ instance that has Hamiltonian cycle is mapped to TSP instance with small cost
- ▶ otherwise it is mapped to instance with large cost
- ▶ \Rightarrow there is no $2^n/n$ -approximation for TSP

PCP theorem: Approximation View

Theorem 97 (PCP Theorem A)

There exists $\epsilon > 0$ for which there is gap introducing reduction between 3SAT and MAX3SAT.

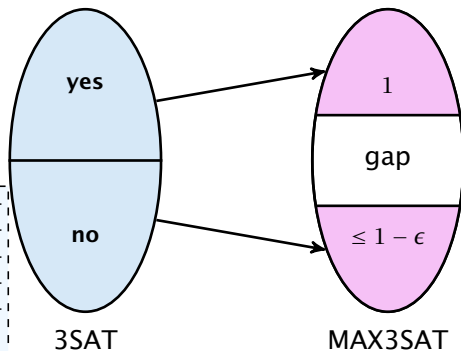

The standard formulation of the PCP theorem looks very different but the above theorem is equivalent. Originally, the PCP theorem is a result about interactive proof systems and its importance to hardness of approximation is somewhat a side effect.

Here the goal of the MAX3SAT-problem is to maximize the **fraction** of satisfied clauses. The above theorem implies that we cannot approximate MAX3SAT with a ratio better than $1 - \epsilon$.

PCP theorem: Proof System View

Definition 98 (NP)

A language $L \in \text{NP}$ if there exists a polynomial time, **deterministic** verifier V (a Turing machine), s.t.

$[x \in L]$ **completeness**

There exists a proof string y , $|y| = \text{poly}(|x|)$,
s.t. $V(x, y) = \text{“accept”}$.

$[x \notin L]$ **soundness**

For any proof string y , $V(x, y) = \text{“reject”}$.

Note that requiring $|y| = \text{poly}(|x|)$ for $x \notin L$ does not make a difference (**why?**).

Probabilistic Checkable Proofs

An **Oracle Turing Machine** M is a Turing machine that has access to an oracle.

Such an oracle allows M to solve some problem in a single step.

For example having access to a TSP-oracle π_{TSP} would allow M to write a TSP-instance x on a special oracle tape and obtain the answer (yes or no) in a single step.

For such TMs one looks in addition to running time also at **query complexity**, i.e., how often the machine queries the oracle.

For a proof string y , π_y is an oracle that upon given an index i returns the i -th character y_i of y .

Probabilistic Checkable Proofs

Non-adaptive means that e.g. the second proof-bit read by the verifier may not depend on the value of the first bit.

Definition 99 (PCP)

A language $L \in \text{PCP}_{c(n),s(n)}(r(n), q(n))$ if there exists a polynomial time, non-adaptive, **randomized** verifier V , s.t.

$[x \in L]$ There exists a proof string y , s.t. $V^{\pi y}(x) =$ “accept” with probability $\geq c(n)$.

$[x \notin L]$ For any proof string y , $V^{\pi y}(x) =$ “accept” with probability $\leq s(n)$.

The verifier uses at most $\mathcal{O}(r(n))$ random bits and makes at most $\mathcal{O}(q(n))$ oracle queries.

Note that the proof itself does not count towards the input of the verifier. The verifier has to write the number of a bit-position it wants to read onto a special tape, and then the corresponding bit from the proof is returned to the verifier. The proof may only be exponentially long, as a polynomial time verifier cannot address longer proofs.

Probabilistic Checkable Proofs

$c(n)$ is called the **completeness**. If not specified otw. $c(n) = 1$.
Probability of accepting a correct proof.

$s(n) < c(n)$ is called the **soundness**. If not specified otw.
 $s(n) = 1/2$. Probability of accepting a wrong proof.

$r(n)$ is called the **randomness complexity**, i.e., how many random bits the (randomized) verifier uses.

$q(n)$ is the **query complexity** of the verifier.

Probabilistic Checkable Proofs

RP = coRP = P is a commonly believed conjecture. RP stands for randomized polynomial time (with a non-zero probability of rejecting a YES-instance).

- ▶ $P = PCP(0, 0)$
verifier without randomness and proof access is deterministic algorithm
- ▶ $PCP(\log n, 0) \subseteq P$
we can simulate $O(\log n)$ random bits in deterministic, polynomial time
- ▶ $PCP(0, \log n) \subseteq P$
we can simulate short proofs in polynomial time
- ▶ $PCP(\text{poly}(n), 0) = \text{coRP} \stackrel{?!}{=} P$
by definition; **coRP** is randomized polytime with one sided error (positive probability of accepting NO-instance)

Note that the first three statements also hold with equality

Probabilistic Checkable Proofs

- ▶ $\text{PCP}(0, \text{poly}(n)) = \text{NP}$
by definition; NP-verifier does not use randomness and asks polynomially many queries
- ▶ $\text{PCP}(\log n, \text{poly}(n)) \subseteq \text{NP}$
NP-verifier can simulate $\mathcal{O}(\log n)$ random bits
- ▶ $\text{PCP}(\text{poly}(n), 0) = \text{coRP} \stackrel{?!}{\subseteq} \text{NP}$
- ▶ $\text{NP} \subseteq \text{PCP}(\log n, 1)$
hard part of the PCP-theorem

PCP theorem: Proof System View

Theorem 100 (PCP Theorem B)

$$\text{NP} = \text{PCP}(\log n, 1)$$

Probabilistic Proof for Graph NonIsomorphism

GNI is the language of pairs of non-isomorphic graphs

Verifier gets input (G_0, G_1) (two graphs with n -nodes)

It expects a proof of the following form:

- ▶ For any **labeled** n -node graph H the H 's bit $P[H]$ of the proof fulfills

$$G_0 \equiv H \implies P[H] = 0$$

$$G_1 \equiv H \implies P[H] = 1$$

$$G_0, G_1 \not\equiv H \implies P[H] = \text{arbitrary}$$

Probabilistic Proof for Graph NonIsomorphism

Verifier:

- ▶ choose $b \in \{0, 1\}$ at random
- ▶ take graph G_b and apply a random permutation to obtain a labeled graph H
- ▶ check whether $P[H] = b$

If $G_0 \not\equiv G_1$ then by using the obvious proof the verifier will always accept.

If $G_0 \equiv G_1$ a proof only accepts with probability $1/2$.

- ▶ suppose $\pi(G_0) = G_1$
- ▶ if we accept for $b = 1$ and permutation π_{rand} we reject for $b = 0$ and permutation $\pi_{\text{rand}} \circ \pi$

Version B \Rightarrow Version A

- ▶ For 3SAT there exists a verifier that uses $c \log n$ random bits, reads $q = \mathcal{O}(1)$ bits from the proof, has completeness 1 and soundness $1/2$.
- ▶ fix x and r :

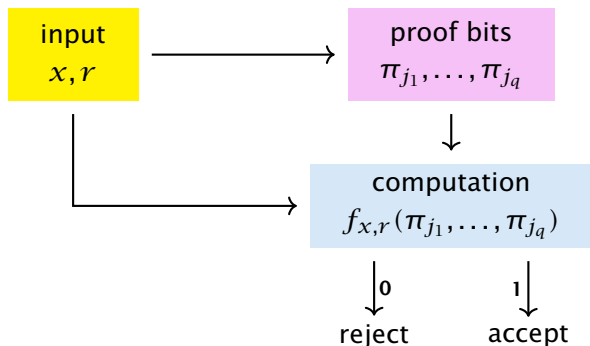

Version B \Rightarrow Version A

- ▶ transform Boolean formula $f_{x,r}$ into 3SAT formula $C_{x,r}$ (constant size, variables are proof bits)
- ▶ consider 3SAT formula $C_x := \bigwedge_r C_{x,r}$

$[x \in L]$ There exists proof string y , s.t. all formulas $C_{x,r}$ evaluate to 1. Hence, all clauses in C_x satisfied.

$[x \notin L]$ For any proof string y , at most 50% of formulas $C_{x,r}$ evaluate to 1. Since each contains only a constant number of clauses, a constant fraction of clauses in C_x are not satisfied.

- ▶ this means we have gap introducing reduction

Version A \Rightarrow Version B

We show: Version A \Rightarrow $\text{NP} \subseteq \text{PCP}_{1,1-\epsilon}(\log n, 1)$.

given $L \in \text{NP}$ we build a PCP-verifier for L

Verifier:

- ▶ 3SAT is NP-complete; map instance x for L into 3SAT instance I_x , s.t. I_x satisfiable iff $x \in L$
- ▶ map I_x to MAX3SAT instance C_x (PCP Thm. Version A)
- ▶ interpret proof as assignment to variables in C_x
- ▶ choose random clause X from C_x
- ▶ query variable assignment σ for X ;
- ▶ accept if $X(\sigma) = \text{true}$ otw. reject

Version A \Rightarrow Version B

- $[x \in L]$ There exists proof string y , s.t. all clauses in C_x evaluate to 1. In this case the verifier returns 1.
- $[x \notin L]$ For any proof string y , at most a $(1 - \epsilon)$ -fraction of clauses in C_x evaluate to 1. The verifier will reject with probability at least ϵ .

To show Theorem B we only need to run this verifier a constant number of times to push rejection probability above $1/2$.

$NP \subseteq PCP(\text{poly}(n), 1)$

Note that this approach has strong connections to error correction codes.

$PCP(\text{poly}(n), 1)$ means we have a potentially **exponentially** long proof but we only read a constant number of bits from it.

The idea is to encode an NP-witness (e.g. a satisfying assignment (say n bits)) by a code whose code-words have 2^n bits.

A wrong proof is either

- ▶ a code-word whose pre-image does not correspond to a satisfying assignment
- ▶ or, a sequence of bits that does not correspond to a code-word

We can detect both cases by querying a few positions.

The Code

$u \in \{0, 1\}^n$ (satisfying assignment)

Walsh-Hadamard Code:

$\text{WH}_u : \{0, 1\}^n \rightarrow \{0, 1\}, x \mapsto x^T u$ (over $\text{GF}(2)$)

The code-word for u is WH_u . We identify this function by a bit-vector of length 2^n .

The Code

Lemma 101

If $u \neq u'$ then WH_u and $WH_{u'}$ differ in at least 2^{n-1} bits.

Proof:

Suppose that $u - u' \neq 0$. Then

$$WH_u(x) \neq WH_{u'}(x) \iff (u - u')^T x \neq 0$$

This holds for 2^{n-1} different vectors x .

The Code

Suppose we are given access to a function $f : \{0, 1\}^n \rightarrow \{0, 1\}$ and want to check whether it is a codeword.

Since the set of codewords is the set of all linear functions $\{0, 1\}^n$ to $\{0, 1\}$ we can check

$$f(x + y) = f(x) + f(y)$$

for all 2^{2n} pairs x, y . **But that's not very efficient.**

$NP \subseteq PCP(\text{poly}(n), 1)$

Can we just check a constant number of positions?

NP \subseteq PCP(poly(n), 1)

Observe that for two codewords
 $\Pr_{x \in \{0,1\}^n} [f(x) = g(x)] = 1/2$.

Definition 102

Let $\rho \in [0, 1]$. We say that $f, g : \{0, 1\}^n \rightarrow \{0, 1\}$ are ρ -close if

$$\Pr_{x \in \{0,1\}^n} [f(x) = g(x)] \geq \rho .$$

Theorem 103 (proof deferred)

Let $f : \{0, 1\}^n \rightarrow \{0, 1\}$ with

$$\Pr_{x, y \in \{0,1\}^n} [f(x) + f(y) = f(x + y)] \geq \rho > \frac{1}{2} .$$

Then there is a linear function \tilde{f} such that f and \tilde{f} are ρ -close.

$\text{NP} \subseteq \text{PCP}(\text{poly}(n), 1)$

We need $\mathcal{O}(1/\delta)$ trials to be sure that f is $(1 - \delta)$ -close to a linear function with (arbitrary) constant probability.

NP \subseteq PCP(poly(n), 1)

Suppose for $\delta < 1/4$ f is $(1 - \delta)$ -close to some linear function \tilde{f} .

\tilde{f} is uniquely defined by f , since linear functions differ on at least half their inputs.

Suppose we are given $x \in \{0, 1\}^n$ and access to f . Can we compute $\tilde{f}(x)$ using only constant number of queries?

NP \subseteq PCP(poly(n), 1)

Suppose we are given $x \in \{0, 1\}^n$ and access to f . Can we compute $\tilde{f}(x)$ using only constant number of queries?

1. Choose $x' \in \{0, 1\}^n$ u.a.r.
2. Set $x'' := x + x'$.
3. Let $y' = f(x')$ and $y'' = f(x'')$.
4. Output $y' + y''$.

x' and x'' are uniformly distributed (albeit dependent). With probability at least $1 - 2\delta$ we have $f(x') = \tilde{f}(x')$ and $f(x'') = \tilde{f}(x'')$.

Then the above routine returns $\tilde{f}(x)$.

This technique is known as local decoding of the Walsh-Hadamard code.

$NP \subseteq PCP(\text{poly}(n), 1)$

We show that $QUADEQ \in PCP(\text{poly}(n), 1)$. The theorem follows since any PCP -class is closed under polynomial time reductions.

QUADEQ

Given a system of quadratic equations over $GF(2)$. Is there a solution?

QUADEQ is NP-complete

- ▶ given 3SAT instance C represent it as Boolean circuit
e.g. $C = (x_1 \vee x_2 \vee x_3) \wedge (x_3 \vee x_4 \vee \bar{x}_5) \wedge (x_6 \vee x_7 \vee x_8)$
- ▶ add variable for every wire
- ▶ add constraint for every gate

OR: $i_1 + i_2 + i_1 \cdot i_2 = o$

AND: $i_1 \cdot i_2 = o$

NEG: $i = 1 - o$

- ▶ add constraint $out = 1$
- ▶ system is feasible iff C is satisfiable

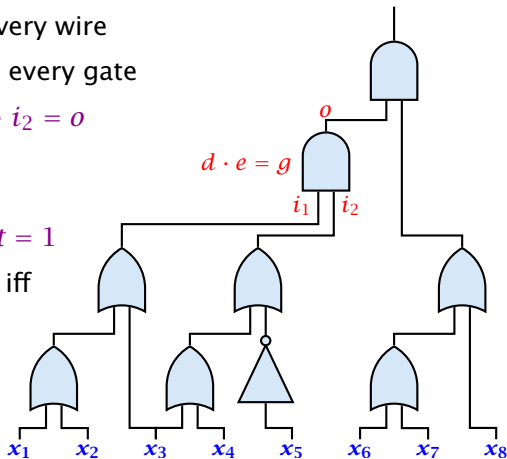

NP \subseteq PCP(poly(n), 1)

Note that over GF(2) $x = x^2$. Therefore, we can assume that there are no terms of degree 1.

We encode an instance of QUADEQ by a matrix A that has n^2 columns; one for every pair i, j ; and a right hand side vector b .

For an n -dimensional vector x we use $x \otimes x$ to denote the n^2 -dimensional vector whose i, j -th entry is $x_i x_j$.

Then we are asked whether

$$A(x \otimes x) = b$$

has a solution.

$\text{NP} \subseteq \text{PCP}(\text{poly}(n), 1)$

Let A, b be an instance of **QUADEQ**. Let u be a satisfying assignment.

The correct PCP-proof will be the Walsh-Hadamard encodings of u and $u \otimes u$. **The verifier will accept such a proof with probability 1.**

We have to make sure that we reject proofs that do not correspond to codewords for vectors of the form u , and $u \otimes u$.

We also have to reject proofs that correspond to codewords for vectors of the form z , and $z \otimes z$, where z is not a satisfying assignment.

$\text{NP} \subseteq \text{PCP}(\text{poly}(n), 1)$

Recall that for a correct proof there is no difference between f and \tilde{f} .

Step 1. Linearity Test.

The proof contains $2^n + 2^{n^2}$ bits. This is interpreted as a pair of functions $f : \{0, 1\}^n \rightarrow \{0, 1\}$ and $g : \{0, 1\}^{n^2} \rightarrow \{0, 1\}$.

We do a 0.999-linearity test for both functions (requires a constant number of queries).

We also assume that for the remaining constant number of accesses WH-decoding succeeds and we recover $\tilde{f}(x)$.

Hence, our proof will only ever see \tilde{f} . To simplify notation we use f for \tilde{f} , in the following (similar for g, \tilde{g}).

$NP \subseteq PCP(\text{poly}(n), 1)$

We need to show that the probability of accepting a wrong proof is small.

This first step means that in order to fool us with reasonable probability a wrong proof needs to be very close to a linear function. The probability that we accept a proof when the functions are not close to linear is just a small constant.

Similarly, if the functions are close to linear then the probability that the Walsh Hadamard decoding fails (for *any* of the remaining accesses) is just a small constant. If we ignore this small constant error then a malicious prover could also provide a linear function (as a near linear function f is “rounded” by us to the corresponding linear function \tilde{f}). If this rounding is successful it doesn’t make sense for the prover to provide a function that is not linear.

NP \subseteq PCP(poly(n), 1)

Step 2. Verify that g encodes $u \otimes u$ where u is string encoded by f .

$f(r) = u^T r$ and $g(z) = w^T z$ since f, g are linear.

- ▶ choose r, r' independently, u.a.r. from $\{0, 1\}^n$
- ▶ if $f(r)f(r') \neq g(r \otimes r')$ reject
- ▶ repeat 3 times

NP \subseteq PCP(poly(n), 1)

$$\begin{aligned} f(r) \cdot f(r') &= u^T r \cdot u^T r' \\ &= \left(\sum_i u_i r_i \right) \cdot \left(\sum_j u_j r'_j \right) \\ &= \sum_{ij} u_i u_j r_i r'_j \\ &= r^T U r' \end{aligned}$$

where U is matrix with $U_{ij} = u_i \cdot u_j$

NP \subseteq PCP(poly(n), 1)

Let W be $n \times n$ -matrix with entries from w . Let U be matrix with $U_{ij} = u_i \cdot u_j$ (entries from $u \otimes u$).

$$g(r \otimes r') = w^T(r \otimes r') = \sum_{ij} w_{ij}r_i r'_j = r^T W r'$$

$$f(r)f(r') = u^T r \cdot u^T r' = r^T U r'$$

If $U \neq W$ then $W r' \neq U r'$ with probability at least $1/2$. Then $r^T W r' \neq r^T U r'$ with probability at least $1/4$.

For a non-zero vector x and a random vector r (both with elements from GF(2)), we have $\Pr[x^T r \neq 0] = \frac{1}{2}$. This holds because the product is zero iff the number of ones in r that "hit" ones in x in the product is even.

NP \subseteq PCP(poly(n), 1)

Step 3. Verify that f encodes satisfying assignment.

We need to check

$$A_k(u \otimes u) = b_k$$

where A_k is the k -th row of the constraint matrix. But the left hand side is just $g(A_k^T)$.

We can handle this by a single query but checking all constraints would take $\mathcal{O}(m)$ steps.

We compute $r^T A$, where $r \in_R \{0, 1\}^m$. If u is not a satisfying assignment then with probability 1/2 the vector r will hit an odd number of violated constraints.

In this case $r^T A(u \otimes u) \neq r^T b$. The left hand side is equal to $g(A^T r)$.

NP \subseteq PCP(poly(n), 1)

We used the following theorem for the linearity test:

Theorem 103

Let $f : \{0, 1\}^n \rightarrow \{0, 1\}$ with

$$\Pr_{x, y \in \{0, 1\}^n} [f(x) + f(y) = f(x + y)] \geq \rho > \frac{1}{2} .$$

Then there is a linear function \tilde{f} such that f and \tilde{f} are ρ -close.

NP \subseteq PCP(poly(n), 1)

Fourier Transform over GF(2)

In the following we use $\{-1, 1\}$ instead of $\{0, 1\}$. We map $b \in \{0, 1\}$ to $(-1)^b$.

This turns summation into multiplication.

The set of function $f : \{-1, 1\}^n \rightarrow \mathbb{R}$ form a 2^n -dimensional **Hilbert space**.

NP \subseteq PCP(poly(n), 1)

Hilbert space

- ▶ addition $(f + g)(x) = f(x) + g(x)$
- ▶ scalar multiplication $(\alpha f)(x) = \alpha f(x)$
- ▶ inner product $\langle f, g \rangle = E_{x \in \{-1, 1\}^n} [f(x)g(x)]$
(bilinear, $\langle f, f \rangle \geq 0$, and $\langle f, f \rangle = 0 \Rightarrow f = 0$)
- ▶ **completeness**: any sequence x_k of vectors for which

$$\sum_{k=1}^{\infty} \|x_k\| < \infty \text{ fulfills } \left\| L - \sum_{k=1}^N x_k \right\| \rightarrow 0$$

for some vector L .

$NP \subseteq PCP(\text{poly}(n), 1)$

standard basis

$$e_x(y) = \begin{cases} 1 & x = y \\ 0 & \text{otw.} \end{cases}$$

Then, $f(x) = \sum_i \alpha_i e_i(x)$ where $\alpha_x = f(x)$, this means the functions e_i form a basis. This basis is orthonormal.

NP \subseteq PCP(poly(n), 1)

fourier basis

For $\alpha \subseteq [n]$ define

$$\chi_\alpha(x) = \prod_{i \in \alpha} x_i$$

Note that

$$\langle \chi_\alpha, \chi_\beta \rangle = E_x[\chi_\alpha(x)\chi_\beta(x)] = E_x[\chi_{\alpha \Delta \beta}(x)] = \begin{cases} 1 & \alpha = \beta \\ 0 & \text{otw.} \end{cases}$$

This means the χ_α 's also define an orthonormal basis. (since we have 2^n orthonormal vectors...)

NP \subseteq PCP(poly(n), 1)

A function χ_α multiplies a set of x_i 's. Back in the GF(2)-world this means summing a set of z_i 's where $x_i = (-1)^{z_i}$.

This means the function χ_α correspond to linear functions in the GF(2) world.

NP \subseteq PCP(poly(n), 1)

We can write any function $f : \{-1, 1\}^n \rightarrow \mathbb{R}$ as

$$f = \sum_{\alpha} \hat{f}_{\alpha} \chi_{\alpha}$$

We call \hat{f}_{α} the α^{th} Fourier coefficient.

Lemma 104

1. $\langle f, g \rangle = \sum_{\alpha} \hat{f}_{\alpha} \hat{g}_{\alpha}$
2. $\langle f, f \rangle = \sum_{\alpha} \hat{f}_{\alpha}^2$

Note that for Boolean functions $f : \{-1, 1\}^n \rightarrow \{-1, 1\}$, $\langle f, f \rangle = 1$.

$$\langle f, f \rangle = E_{\mathbf{x}}[f(\mathbf{x})^2] = 1$$

Linearity Test

in GF(2):

We want to show that if $\Pr_{x,y}[f(x) + f(y) = f(x + y)]$ is large than f has a large agreement with a linear function.

in Hilbert space: (we will prove)

Suppose $f : \{\pm 1\}^n \rightarrow \{-1, 1\}$ fulfills

$$\Pr_{x,y}[f(x)f(y) = f(x \circ y)] \geq \frac{1}{2} + \epsilon .$$

Then there is some $\alpha \subseteq [n]$, s.t. $\hat{f}_\alpha \geq 2\epsilon$.

Here $x \circ y$ denotes the n -dimensional vector with entry $x_i y_i$ in position i (**Hadamard product**).
Observe that we have $\chi_\alpha(x \circ y) = \chi_\alpha(x)\chi_\alpha(y)$.

Linearity Test

For Boolean functions $\langle f, g \rangle$ is the fraction of inputs on which f, g agree **minus** the fraction of inputs on which they disagree.

$$2\epsilon \leq \hat{f}_\alpha = \langle f, \chi_\alpha \rangle = \text{agree} - \text{disagree} = 2\text{agree} - 1$$

This gives that the agreement between f and χ_α is at least $\frac{1}{2} + \epsilon$.

Linearity Test

$$\Pr_{x,y}[f(x \circ y) = f(x)f(y)] \geq \frac{1}{2} + \epsilon$$

means that the fraction of inputs x, y on which $f(x \circ y)$ and $f(x)f(y)$ agree is at least $1/2 + \epsilon$.

This gives

$$\begin{aligned} E_{x,y}[f(x \circ y)f(x)f(y)] &= \text{agreement} - \text{disagreement} \\ &= 2\text{agreement} - 1 \\ &\geq 2\epsilon \end{aligned}$$

$$\begin{aligned}
2\epsilon &\leq E_{x,y} \left[f(x \circ y) f(x) f(y) \right] \\
&= E_{x,y} \left[\left(\sum_{\alpha} \hat{f}_{\alpha} \chi_{\alpha}(x \circ y) \right) \cdot \left(\sum_{\beta} \hat{f}_{\beta} \chi_{\beta}(x) \right) \cdot \left(\sum_{\gamma} \hat{f}_{\gamma} \chi_{\gamma}(y) \right) \right] \\
&= E_{x,y} \left[\sum_{\alpha,\beta,\gamma} \hat{f}_{\alpha} \hat{f}_{\beta} \hat{f}_{\gamma} \chi_{\alpha}(x) \chi_{\alpha}(y) \chi_{\beta}(x) \chi_{\gamma}(y) \right] \\
&= \sum_{\alpha,\beta,\gamma} \hat{f}_{\alpha} \hat{f}_{\beta} \hat{f}_{\gamma} \cdot E_x \left[\chi_{\alpha}(x) \chi_{\beta}(x) \right] E_y \left[\chi_{\alpha}(y) \chi_{\gamma}(y) \right] \\
&= \sum_{\alpha} \hat{f}_{\alpha}^3 \\
&\leq \max_{\alpha} \hat{f}_{\alpha} \cdot \sum_{\alpha} \hat{f}_{\alpha}^2 = \max_{\alpha} \hat{f}_{\alpha}
\end{aligned}$$

Label Cover

Input:

- ▶ bipartite graph $G = (V_1, V_2, E)$
- ▶ label sets L_1, L_2
- ▶ for every edge $(u, v) \in E$ a relation $R_{u,v} \subseteq L_1 \times L_2$ that describe assignments that make the edge **happy**.
- ▶ maximize number of happy edges

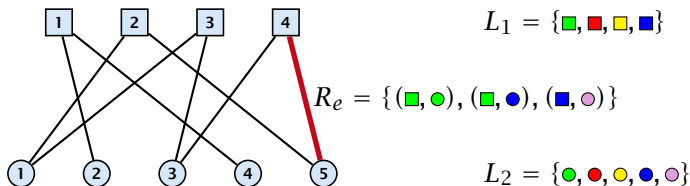

The label cover problem also has its origin in proof systems. It encodes a 2PR1 (2 prover 1 round system). Each side of the graph corresponds to a prover. An edge is a query consisting of a question for prover 1 and prover 2. If the answers are consistent the verifier accepts otherwise it rejects.

Label Cover

- ▶ an instance of label cover is (d_1, d_2) -regular if every vertex in L_1 has degree d_1 and every vertex in L_2 has degree d_2 .
- ▶ if every vertex has the same degree d the instance is called d -regular

MAX E3SAT via Label Cover

instance:

$$\Phi(x) = (x_1 \vee \bar{x}_2 \vee x_3) \wedge (x_4 \vee x_2 \vee \bar{x}_3) \wedge (\bar{x}_1 \vee x_2 \vee \bar{x}_4)$$

corresponding graph:

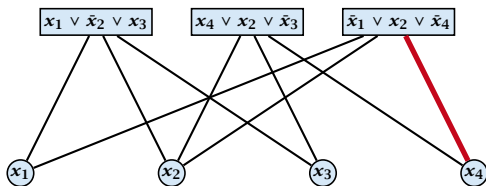

The verifier accepts if the labelling (assignment to variables in clauses at the top + assignment to variables at the bottom) causes the clause to evaluate to true and is consistent, i.e., the assignment of e.g. x_4 at the bottom is the same as the assignment given to x_4 in the labelling of the clause.

label sets: $L_1 = \{T, F\}^3, L_2 = \{T, F\}$ (T =true, F =false)

relation: $R_{C, x_i} = \{((u_i, u_j, u_k), u_i)\}$, where the clause C is over variables x_i, x_j, x_k and assignment (u_i, u_j, u_k) satisfies C

$$R = \{((F, F, F), F), ((F, T, F), F), ((F, F, T), T), ((F, T, T), T), ((T, T, T), T), ((T, T, F), F), ((T, F, F), F)\}$$

MAX E3SAT via Label Cover

Lemma 105

If we can satisfy k out of m clauses in ϕ we can make at least $3k + 2(m - k)$ edges happy.

Proof:

- ▶ for V_2 use the setting of the assignment that satisfies k clauses
- ▶ for satisfied clauses in V_1 use the corresponding assignment to the clause-variables (gives $3k$ happy edges)
- ▶ for unsatisfied clauses flip assignment of one of the variables; this makes one incident edge unhappy (gives $2(m - k)$ happy edges)

Lemma 106

If we can satisfy at most k clauses in Φ we can make at most $3k + 2(m - k) = 2m + k$ edges happy.

Proof:

- ▶ the labeling of nodes in V_2 gives an assignment
- ▶ every unsatisfied clause in this assignment cannot be assigned a label that satisfies all 3 incident edges
- ▶ hence at most $3k + 2(m - k) = 2m + k$ edges are happy

We cannot distinguish between the following two cases

- ▶ all $3m$ edges can be made happy
- ▶ at most $2m + (1 - \epsilon)m = (3 - \epsilon)m$ out of the $3m$ edges can be made happy

Hence, we cannot obtain an approximation constant $\alpha > \frac{3-\epsilon}{3}$.

(3, 5)-regular instances

Theorem 107

There is a constant ρ s.t. MAXE3SAT is hard to approximate with a factor of ρ even if restricted to instances where a variable appears in exactly 5 clauses.

Then our reduction has the following properties:

- ▶ the resulting Label Cover instance is (3, 5)-regular
- ▶ it is hard to approximate for a constant $\alpha < 1$
- ▶ given a label ℓ_1 for x there is at most one label ℓ_2 for y that makes edge (x, y) happy (**uniqueness property**)

(3, 5)-regular instances

The previous theorem can be obtained with a series of **gap-preserving reductions**:

- ▶ $\text{MAX3SAT} \leq \text{MAX3SAT}(\leq 29)$
- ▶ $\text{MAX3SAT}(\leq 29) \leq \text{MAX3SAT}(\leq 5)$
- ▶ $\text{MAX3SAT}(\leq 5) \leq \text{MAX3SAT}(= 5)$
- ▶ $\text{MAX3SAT}(= 5) \leq \text{MAXE3SAT}(= 5)$

Here $\text{MAX3SAT}(\leq 29)$ is the variant of MAX3SAT in which a variable appears in at most 29 clauses. Similar for the other problems.

Regular instances

We take the $(3, 5)$ -regular instance. We make 3 copies of every clause vertex and 5 copies of every variable vertex. Then we add edges between clause vertex and variable vertex iff the clause contains the variable. This increases the size by a constant factor. The gap instance can still either only satisfy a constant fraction of the edges or all edges. The uniqueness property still holds for the new instance.

Theorem 108

There is a constant $\alpha < 1$ such if there is an α -approximation algorithm for Label Cover on 15-regular instances then $P=NP$.

Given a label ℓ_1 for $x \in V_1$ there is at most one label ℓ_2 for y that makes (x, y) happy. (**uniqueness property**)

Parallel Repetition

We would like to increase the inapproximability for Label Cover.

In the verifier view, in order to decrease the acceptance probability of a wrong proof (or as here: a pair of wrong proofs) one could repeat the verification several times.

Unfortunately, we have a 2P1R-system, i.e., we are stuck with a single round and cannot simply repeat.

The idea is to use **parallel repetition**, i.e., we simply play several rounds in parallel and hope that the acceptance probability of wrong proofs goes down.

Parallel Repetition

Given Label Cover instance I with $G = (V_1, V_2, E)$, label sets L_1 and L_2 we construct a new instance I' :

- ▶ $V'_1 = V_1^k = V_1 \times \cdots \times V_1$
- ▶ $V'_2 = V_2^k = V_2 \times \cdots \times V_2$
- ▶ $L'_1 = L_1^k = L_1 \times \cdots \times L_1$
- ▶ $L'_2 = L_2^k = L_2 \times \cdots \times L_2$
- ▶ $E' = E^k = E \times \cdots \times E$

An edge $((x_1, \dots, x_k), (y_1, \dots, y_k))$ whose end-points are labelled by $(\ell_1^x, \dots, \ell_k^x)$ and $(\ell_1^y, \dots, \ell_k^y)$ is happy if $(\ell_i^x, \ell_i^y) \in R_{x_i, y_i}$ for all i .

Parallel Repetition

If I is regular than also I' .

If I has the uniqueness property than also I' .

Did the gap increase?

- ▶ Suppose we have labelling ℓ_1, ℓ_2 that satisfies just an α -fraction of edges in I .
- ▶ We transfer this labelling to instance I' :
vertex (x_1, \dots, x_k) gets label $(\ell_1(x_1), \dots, \ell_1(x_k))$,
vertex (y_1, \dots, y_k) gets label $(\ell_2(y_1), \dots, \ell_2(y_k))$.
- ▶ How many edges are happy?
only $(\alpha|E|)^k$ out of $|E|^k$!!! (just an α^k fraction)

Does this always work?

Counter Example

Non interactive agreement:

- ▶ Two provers A and B
- ▶ The verifier generates two random bits b_A , and b_B , and sends one to A and one to B .
- ▶ Each prover has to answer one of A_0, A_1, B_0, B_1 with the meaning $A_0 :=$ prover A has been given a bit with value 0.
- ▶ The provers win if they give **the same answer** and if the **answer is correct**.

Counter Example

The provers can win with probability at most $1/2$.

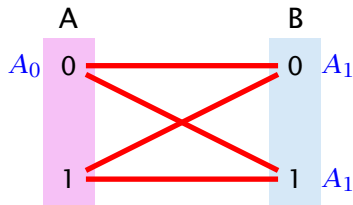

Regardless what we do 50% of edges are unhappy!

Counter Example

In the repeated game the provers can also win with probability $1/2$:

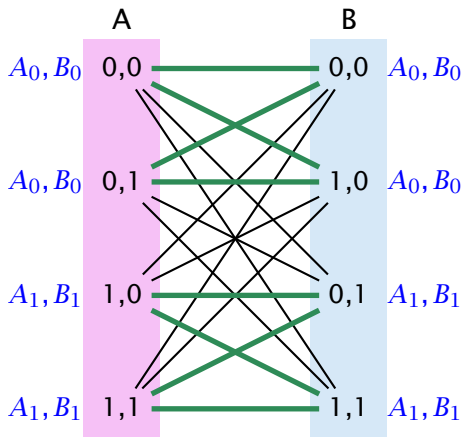

For the first game/coordinate the provers give an answer of the form "A has received..." (A_0 or A_1) and for the second an answer of the form "B has received..." (B_0 or B_1).

If the answer a prover has to give is about himself a prover can answer correctly. If the answer to be given is about the other prover the same bit is returned. This means e.g. Prover B answers A_1 for the first game iff in the second game he receives a 1-bit.

By this method the provers always win if Prover A gets the same bit in the first game as Prover B in the second game. This happens with probability $1/2$.

This strategy is not possible for the provers if the game is repeated sequentially. How should prover B know (for her answer in the first game) which bit she is going to receive in the second game?

Theorem 109

There is a constant $c > 0$ such if $\text{OPT}(I) = |E|(1 - \delta)$ then $\text{OPT}(I') \leq |E'|(1 - \delta)^{\frac{ck}{\log L}}$, where $L = |L_1| + |L_2|$ denotes total number of labels in I .

proof is highly non-trivial

Hardness of Label Cover

Theorem 110

There are constants $c > 0$, $\delta < 1$ s.t. for any k we cannot distinguish regular instances for Label Cover in which either

- ▶ $\text{OPT}(I) = |E|$, or
- ▶ $\text{OPT}(I) = |E|(1 - \delta)^{ck}$

unless each problem in NP has an algorithm running in time $\mathcal{O}(n^{\mathcal{O}(k)})$.

Corollary 111

There is no α -approximation for Label Cover for *any* constant α .